

ZANUSSI

TUMBLE DRYER TDE 4224 W

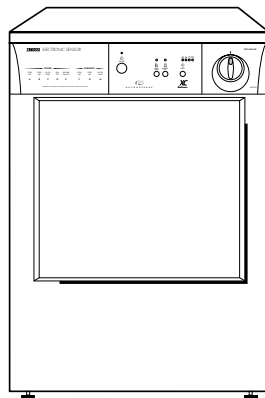

 **Unpacking:** see page 18



Important Safety Information

It is most important that this instruction book should be retained with the appliance for future reference. Should the appliance be sold or transferred to another owner, or should you move house and leave the appliance, always ensure that the book is supplied with the appliance in order that the new owner can get to know the functioning of the appliance and the relevant warnings.

These warnings have been provided in the interest of safety. You **MUST** read them carefully before installing or using the appliance.

Installation

- This appliance is heavy. Care should be taken when moving it.
- It is dangerous to alter the specifications or attempt to modify this product in any way.
- Any electrical work required to install this appliance should be carried out by a qualified electrician or competent person.
- Care must be taken to ensure that the appliance does not stand on the electrical supply cable.
- If the machine is situated on a carpeted floor, please adjust the feet in order to allow air to circulate freely.
- If the tumble dryer is placed on top of a washing machine, it is compulsory to use the stacking kit (optional accessory).
- This tumble dryer is designed to be vented through to the open air. It should have its own ventilation system which should not be joined with any other ventilation system connected to any other appliance.

Child Safety

- This appliance is designed to be operated by adults. Children should not be allowed to tamper with the controls or play with the product.
- Pets and children have been known to climb into tumble dryers. Please check your drum before use.
- Keep all packaging well away for children.

Use

- Do not overload the appliance (see programme chart).
- Clothes which are dripping wet should not be placed in the dryer.
- As some bulky items such as duvets and eiderdowns should be dried in large commercial machines because of their bulk, check with the manufacturer of the item if it is suitable for drying in a domestic machine, even if the dry weight of the item is within the limit advised.
- Please make sure that no gas lighters have accidentally been left in pockets of garments to be loaded into appliance.
- **Danger of explosion:** Never tumble dry items that have been in contact with inflammable solvents (petrol, methylated spirits, dry cleaning fluid and the like). As these substance are volatile, they could cause an explosion. Tumble dry only items washed with water.
- In order to avoid danger of fires caused by excessive drying, do not use appliance to dry the following items:
Cushions, quilts and the like (these items accumulate heat).
Items containing rubber foam or materials similar to rubber foam.
- Leave the door slightly ajar when the appliance is not being used. This will allow the seal to be preserved.
- Clean fluff filters after using tumble dryer. To prevent fire risks, do not use the appliance if the fluff filters are damaged.
- Under no circumstances should you attempt to repair the machine yourself. Repairs carried out by inexperienced persons may cause injury or serious malfunctioning. Contact your local Zanussi Service Centre. Always insist on genuine Zanussi spare parts.

Contents

For the User

Important Safety Information	2
■ Installation	2
■ Child Safety	2
■ Use	2
Your New Tumble Dryer	4
Description of the Appliance	5
The Control Panel	6-7
■ Mains-on light	6
■ Buttons	6
■ Control lights	6
■ Programme/Time Selector Dial	6
Programme Chart	8
Operating Sequence	9-10
■ Load the laundry	9
■ Switch the machine on	9
■ Select the drying time or programme	9
■ Select the required options	9
■ Start the machine	9
■ When drying is completed	9
■ Antcrease phase	10
Hints & Tips on Drying	11
Maintenance and Cleaning	12
■ External cleaning	12
■ Cleaning the door	12
■ Cleaning fluff filters	12
Something Not Working	13
Service and Spare Parts	13
Customer Care	13
Guarantee Conditions	14
Zanussi Service Force	15-16

For the Installer

Installation Instructions	17
Technical Specifications	17
■ Unpacking	18
■ Positioning	18
■ Fitting the vent hose	18-19
■ Door reversal	19
■ Stacking kit (optional accessory)	19
■ Electrical connection	20

Guide to use the Instruction Book

The following symbols will be found in the text to guide you throughout the instructions:



Safety instructions



Hints and tips



Environmental information



Your New Tumble Dryer

This tumble dryer will give your wash that soft, relaxed feel whatever the weather.

Extremely high quality standards both during development and manufacturing guarantee a long service life for your appliance.

Maximum economy in the operation of your dryer is achieved through very frugal electricity consumption and short drying times.

Energy saving tips

To save energy we recommend that you follow these hints:

- Try to load the maximum capacity of the machine as small loads are **uneconomical**.
- Always load well spun laundry. The higher the spin speed, the lower the electricity consumption and the shorter the drying times.
- Do not over-dry laundry, this avoids creasing and saves energy.
- Clean the filters regularly to avoid excessive drying times and high electricity consumption.
- Ventilate the room well. The room temperature should not exceed +35°C during drying.



In the interest of the environment

- Materials marked with the symbol  are recyclable.
- Check with your local Council or Environmental Health Office to see if there are facilities in your area for re-cycling this appliance.
- When the appliance is to be scrapped, cut off the power supply cable and make the door closing device unusable to prevent young children from being trapped inside.
- Help to keep your country tidy - use authorised disposal sites for your old appliance.

How do we help to protect the environment? We use recycled paper!

Description of the Appliance

- 1 Worktop
- 2 Programme Chart
- 3 On-Off Button
- 4 Mains-On Light
- 5 Low Temperature Button
- 6 Buzzer Off Button
- 7 Start Button
- 8 Control Lights
- 9 Programme/Time Selector Dial
- 10 Fluff filters
- 11 Rating Plate
- 12 Adjustable feet

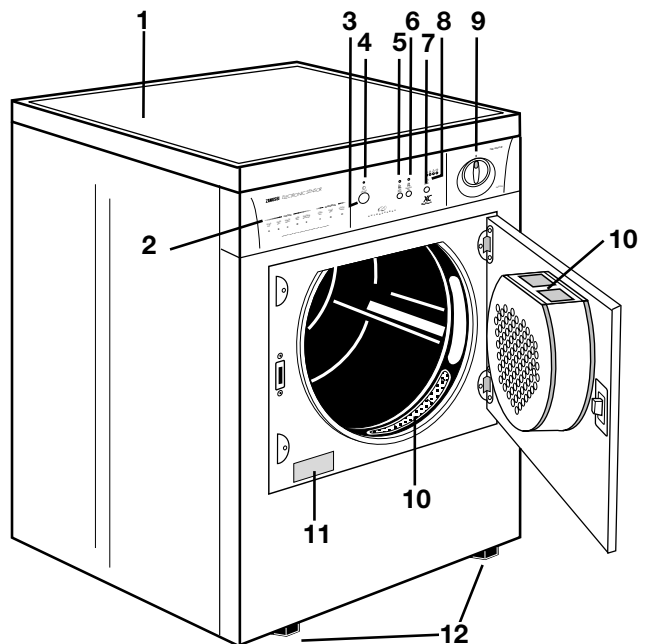

- 13 Side vent outlet
- 14 Ring nut
- 15 Rear vent outlet

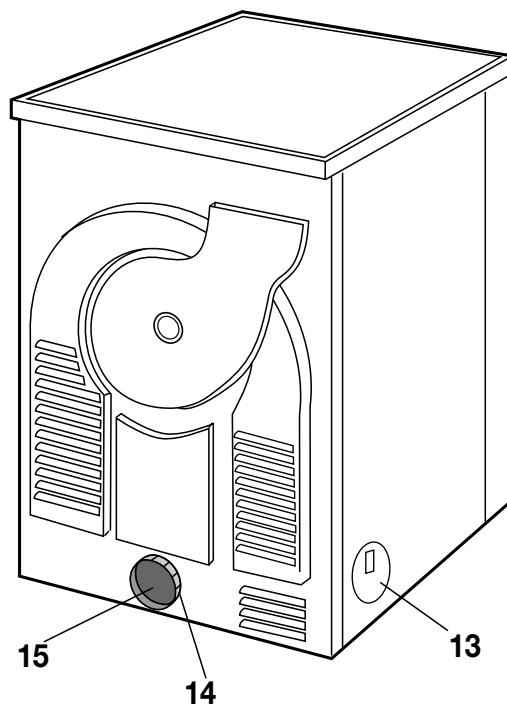

The Control Panel

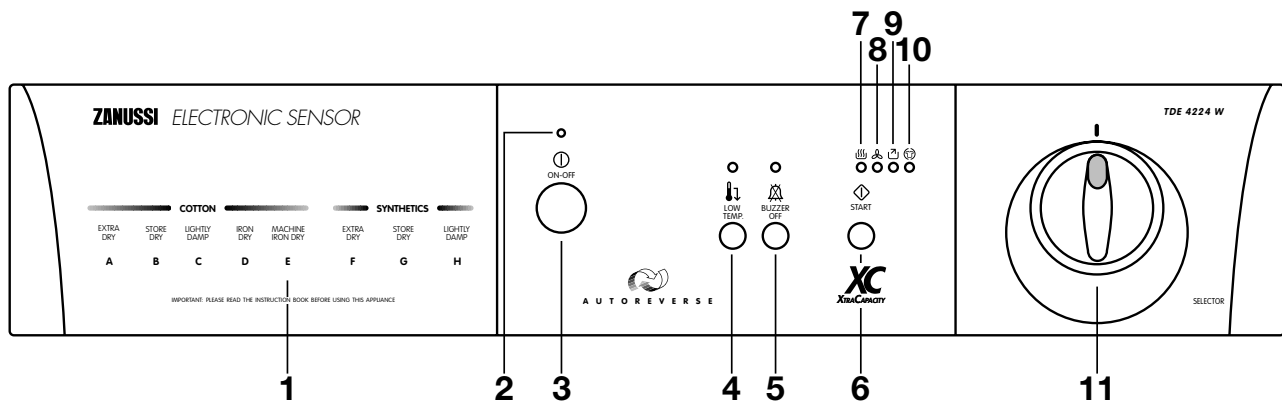

1 Programme Chart

This will help you to select the correct programme for drying.

2 Mains-On Light

It comes on when the appliance is switched on (ON-OFF button pressed down) and goes out when this button is released.

3 ON-OFF Button

This button is used to switch the dryer on. At the end of the programme, release this button by pressing it again to switch the dryer off.

4 Low Temperature Button

Pressing this button allows drying to be performed at a lower temperature, for delicate items. The corresponding pilot light comes on.



5 Buzzer OFF Button

A buzzer sounds during the anti-creasing phase. Press this button when selecting the programme if you wish to switch the buzzer off. The corresponding light illuminates.

6 Start Button

Press this button for about 2 seconds to start the dryer after having selected the drying programme.



If the door is opened while the programme is running, this button must be pressed again after closing the door in order to re-start the programme from the point at which it was interrupted.

This button must also be pressed after a power cut. In both cases light  or  (depending on the phase in progress) flashes to remind you that the start button needs to be pressed again.

7 “Drying” Light

This light indicates that the machine is performing the drying phase.

8 “Cooling” Light

This light indicates that the appliance is in the cooling phase. At the end of drying, there is a 10 minute cooling phase to cool the laundry. If light  or  is flashing, this means that the Start Button needs to be pressed again for the programme to resume.

9 “End of Programme” Light

This light flashes at the end of the cooling phase and during the anti-creasing phase.

10 “Anti-creasing” Light

This light flashes alternately with the light  at the end of the drying phase (after cooling) and during the anti-creasing phase.

If only light  flashes, this means that the anti-creasing phase has finished.

11 Programme/Time Selector Dial

It allows you to select electronically controlled or time controlled drying.

Turn the dial to the required programme or time.

Electronic controlled programmes

The appliance runs these programmes with the help of probes which detect the degree of dampness of the laundry.

Simply select the programme according to the type of laundry and degree of drying required.

Timed controlled drying

It can be used to finish off drying if necessary.

Select the 60 minute programme for cottons or the 30 minute programme for synthetics.

To cancel a programme which is running, turn the programme selector dial to **“0”**.

At the end of drying, turn the selector dial to **“0”** before removing the laundry.

Programme Chart

Automatic drying (Electronic Programmes)

Type of laundry:	Degree of drying required	Max. amount of laundry in kg	Programme
Cotton & Linen	Extra dry	6	A
	Store dry	6	B(*)
	Lightly damp	6	C
	Iron dry	6	D(*)
	Machine iron dry	6	E
Synthetics	Extra dry	2.5	F
	Store dry	2.5	G(*)
	Lightly damp	2.5	H

(*) According to CEI 1121 standards.

Timed controlled drying

Type of laundry:	Drying time	Max. amount of laundry in kg	Programme selector dial position
Cotton & Linen	60 min	6	60'
Synthetics	30 min	2.5	30'

Never overfill the drum (do not load large quilts, for example).

Drying times vary according to:

- The type of laundry
- The size of the load
- The degree of spinning prior to drying
- The degree of drying required

Fresh & Cool

This position on programme selector dial can be used to freshen the laundry (e.g. to remove a persistent odour of moth-balls).

Load

It is often difficult to estimate the weight of items to be dried. We therefore recommend that you adopt the following guidelines:

- cotton, linen: drum full but not too tightly packed
- synthetics: drum no more than half full

Operating Sequence

Before using your tumble dryer for the first time, we recommend to place a few damp cloths inside the appliance and dry for approximately 30 minutes. There may be dust inside a brand new tumble dryer.

1. Load the laundry

Open the door by pressing on the left side as per picture.

Load the items one at a time, shaking them out loosely and close the door.

Please check the laundry does not get caught between the door and filter.

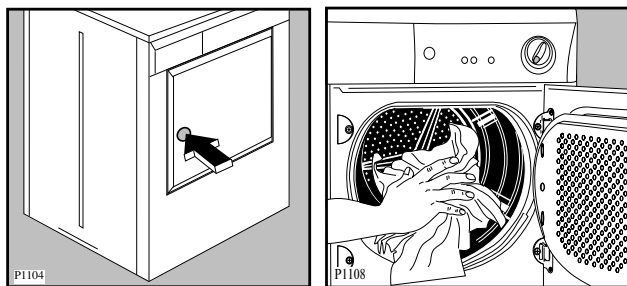

2. Switch the machine on

Press the ON-OFF Button : the mains-on light comes on.

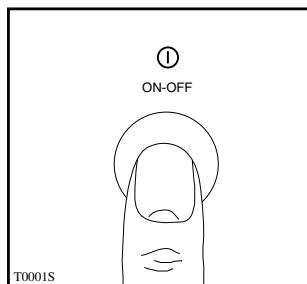

3. Select the drying time or the drying programme

Turn the selector dial to the desired programme or time.

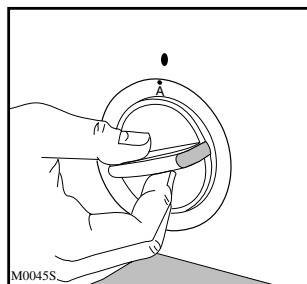

4. Select the required options

Depress Buzzer Off and/or Low Temp. Button, if you have to dry particularly delicate items.

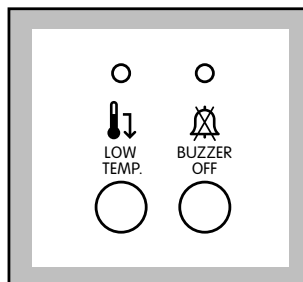

5. Start the machine

Depress START button for 2 seconds, the machine starts operating and the drying light  comes on.

To change a programme already in progress, turn the selector dial to "0", select the new programme and then depress START button.

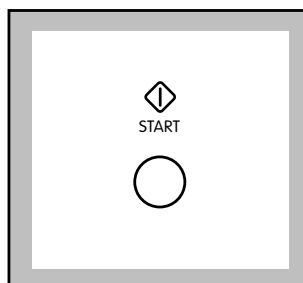

Important!

If the drying programme has to be stopped before it reaches the end, we recommend that you turn the programme selector dial to position  (cooling) and wait until the end of this phase before removing the laundry. This will avoid a build-up of heat inside the appliance.



6. When drying is completed

The machine stops automatically. The control light  is flashing.

Turn the selector dial to "0", the control light  goes out.

Release ON-OFF Button (the mains-ON light goes out) and immediately remove the laundry.

Anti-crease phase





If you do not remove the laundry at the end of the programme, the machine will automatically carry out an “antcrease” phase for approx 30 mins. During this period the drum will rotate at regular intervals to avoid creasing and the buzzer will sound for 1 second every 10 seconds, unless you have depressed the BUZZER OFF button. The lights  and  will flash alternatively.

**Clean the filters after every drying programme.
Clean filters ensure correct functioning of the appliance.**

Hints & Tips on Drying

Before placing articles of laundry in your tumble dryer, check the care labels to ensure they are recommended for tumble drying.

Care Labels you may find on your laundry

-  normal drying (high temperature)
-  delicate drying (low temperature)
-  may be tumble dried
-  do not tumble dry

 **Do not overload the appliance.**

Here is a list of the approximate weight of some common laundry items.

Sheet	700 to 1000 g
Pillowcase	100 to 200 g
Tablecloth	400 to 500 g
Table Napkin	50 to 100 g
Kitchen Towel	70 to 120 g
Linen Hand Towel	100 to 150 g
Hand Towel	150 to 250 g
Bath Towel	700 to 1000 g
Bathrobe	1000 to 1500 g
Shirt	200 to 300 g
Apron	150 to 200 g

- Always load well spun laundry. The higher the spin speed the lower the electricity consumption and the shorter the drying time.
- DO NOT load dripping wet laundry into the dryer. Roll the article in a towel or spin to remove excess water.
- Close poppers and zips and fasten any buttons.
- Sort the laundry. Separate synthetics from cotton/linens, and dry separately.
- Remove the laundry immediately after the programme has finished.
- Use a fabric conditioning sheet to reduce static. We recommend the sheet is pinned to an article of laundry (using a safety pin).
- Mix the load i.e. large and small articles.
- When drying large items such as sheets, we recommend you periodically stop the dryer to redistribute the load.

DO NOT use the tumble dryer to dry the following:

- Articles contaminated with inflammable substances e.g. petrol, cleaning solvents, cooking oil, fats or hair lacquer.
- Woollen and synthetic/wool mixtures unless the item is labelled as suitable for tumble drying.
- Very delicate articles such as silk.
- Very large and bulky items such as duvets or sleeping bags.

Maintenance and Cleaning

You must **disconnect** the appliance from the electricity supply, before you can carry out any cleaning or maintenance work.

External cleaning

Use only soap and water and then dry thoroughly.

Important: do not use methylated spirit, diluents or similar products.

Cleaning the door

Clean periodically the interior part of the door to remove any fluff from the seals around the filter. Regular cleaning ensures correct drying.

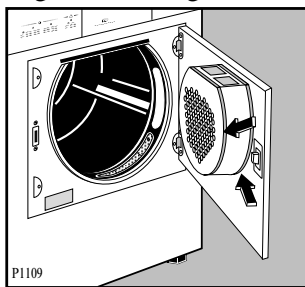

If necessary the filters can be cleaned under running water using a brush. In this case, remove the filter in the door opening as per picture (it can be positioned with the tongue facing to the left or to the right).

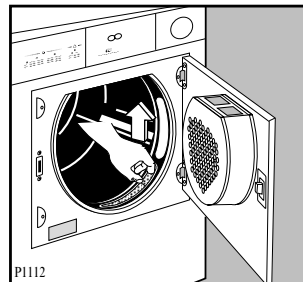

Cleaning the filters

Your dryer will only function well if the filters are clean.

The filters collect all the fluff which accumulates during drying and they must therefore be cleaned at the end of each programme, before removing the laundry, with a damp cloth.

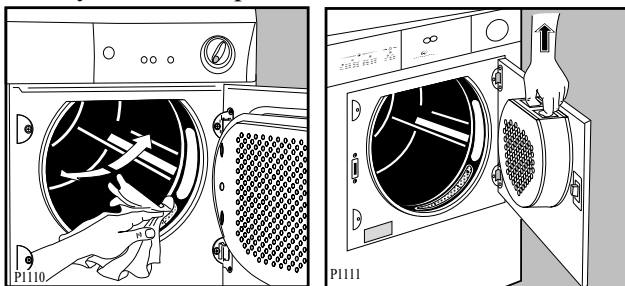



The filter in the inner door must be removed for cleaning.

Do not be alarmed by the amount of fluff. It is not due to excessive wear caused by the dryer. All fabric loses fluff when drying but it goes un-noticed in the air. In a tumble dryer it simply collects in the filter.

Something Not Working

Certain problems are due to lack of simple maintenance or oversights, which can be solved easily without calling out an engineer. Before contacting your local Service Centre, please carry out the checks listed below.

IMPORTANT: if you call out an engineer to a fault listed below, or to repair a fault caused by incorrect use or installation, a charge will be made even if the appliance is under guarantee.

Symptom	Possible causes
The tumble dryer does not start	<ul style="list-style-type: none"> ■ The door has not been closed. ■ The plug is not properly inserted in the power socket. ■ There is no current at the socket. ■ The main fuse or the fuse in the plug has blown. ■ A drying programme or time has not been selected. ■ The Start Button  has not been depressed.
Drying takes too long or laundry is not dry enough.	<ul style="list-style-type: none"> ■ The laundry has not been spun properly. ■ The filters are clogged up. ■ The room temperature is too high. ■ The selected drying cycle was not suitable for the laundry. ■ The low temperature button  has been pressed. ■ There is too much laundry inside the appliance. ■ The dryer is not correctly installed.

If after the above checks, there is still a fault, call your local Zanussi Service Force Centre.

Service & Spare Parts

In the event of your appliance requiring service, or if you wish to purchase spare parts, please contact your local Zanussi Service Force Centre by telephoning:

0870 5 929929

Your telephone call will be automatically routed to the Service Force Centre covering your post code area.

The addresses are listed on the following pages. Before calling out an engineer, please ensure you have read the details under the heading “Something Not Working”.

When you contact the Service Force Centre you will need to give the following details:

1. Your name, address and post code
2. Your telephone number
3. Clear and concise details of fault
4. The model and serial number of the appliance (found on the rating plate - see picture on page 5).
5. The purchase date

Customer Care

For general enquiries concerning your Zanussi appliance or for further information on Zanussi products, please contact our Customer Care Department by letter or telephone as follows:

Customer Care Department

Zanussi

55-77 High Street

Slough

Berkshire

SL1 1DZ

Tel 08705 727727*

or visit our website at www.zanussi.co.uk

* calls to this number may be recorded for training purposes.

Guarantee Conditions

Standard guarantee conditions

We, Zanussi undertake that if, within 12 months of the date of the purchase, this Zanussi appliance or any part thereof is proved to be defective by reason only of faulty workmanship or materials, we will, at our option, repair or replace the same **FREE OF ANY CHARGE** for labour, materials or carriage on condition that:

- The appliance has been correctly installed and used only on the electricity supply stated on the rating plate.
- The appliance has been used for normal domestic purposes only, and in accordance with the manufacturer's instructions.
- The appliance has not been serviced, maintained, repaired, taken apart or tampered with, by any person not authorised by us.

All service work under this guarantee must be undertaken by a Zanussi Service Force Centre.

Any appliance or defective part replaced shall become the Company's property.

This guarantee is in addition to your statutory and other legal rights.

Home visits are made between **8.30am** and **5.30pm** Monday to Friday. Visits may be available outside these hours in which case a **premium** will be charged.

Exclusions

This guarantee does not cover:

- Damage or calls resulting from transportation, improper use or neglect, the replacement of any light bulbs or removable parts of glass or plastic.
- Costs incurred for calls to put right an appliance which is improperly installed or calls to appliances outside the United Kingdom.
- Appliances found to be in use within a commercial environment, plus those which are subject to rental agreements.
- Products of Zanussi manufacture which are **NOT** marketed by Zanussi.

European guarantee

If you should move to another country within Europe then your guarantee moves with you to your new home subject to the following qualifications:

- The guarantee starts from the date you first purchased your product.
- The guarantee is for the same period and to the same extent for labour and parts as exists in the new country of use for this brand or range of products.
- The guarantee relates to you and cannot be transferred to another user.
- Your new home is within the European Community (EC) or European Free Trade Area.
- The product is installed and used in accordance with our instructions and is only used domestically, i.e. a normal household.
- The product is installed taking into account regulations in your new country.

Before you move please contact your nearest Customer Care Centre, listed below, to give them details of your new home. They will then ensure that the local Service Organisation is aware of your move and able to look after you and your appliances.

France	Senlis	+33 (0)344 62 22 22
Germany	Nurnberg	+49 (0)911 323 2600
Italy	Pordenone	+39 (0)1678 47053
Sweden	Stockholm	+46 (0)8 738 79 50
UK	Slough	+44 (0)1753 219897

SERVICE FORCE



To contact your local Service Force Centre telephone 08705 929 929

<p style="text-align: center;">CHANNEL ISLANDS</p> <p>GUERNSEY Guernsey Electricity PO Box 4 Vale, Guernsey Channel Islands GY1 3AD</p> <hr/> <p>JERSEY Jersey Electricity Company Haut De L'orme Rue De Haut De L'orme Trinity Jersey Channel Islands JE3 5FG</p>	<p>ISLE OF LEWIS ND Macleod 16 James Street Stornoway Isle of Lewis PA87 2QW</p> <hr/> <p>KELSO 2, 6 & 8 Woodmarket Kelso Borders TD5 7AX</p> <hr/> <p>ORKNEY 7 King Street Kirkwall Orkney KW15 1JF</p> <hr/> <p>PERTH Scottish Hydro Electric Central Warehouse Inveralmond Perth PH1 3AF (OWN SALES)</p> <hr/> <p>SHETLAND 3-4 Carlton Place Lerwick Shetland ZE1 0PW (OWN SALES)</p> <hr/> <p>SHETLAND Bolts Shetland 26 North Road Lerwick Shetland ZE1 0PE (OWN SALES)</p> <hr/> <p>WHALSAY Leask Electrical Harisdale Symbister, Whalsay Shetland ZE2 9AA (OWN SALES)</p>	<p style="text-align: center;">NORTH EAST</p> <p>GATESHEAD Unit 356a Dukesway Court Dukesway Gateshead NE11 0BH</p> <hr/> <p>GRIMSBY 15 Hainton Avenue Grimsby N. E. Lincs DN32 9AS</p> <hr/> <p>HULL Unit 1 Boulevard Industrial Estate Hull HU3 4AY</p> <hr/> <p>LEEDS 64-66 Cross Gates Road Cross Gates Leeds LS15 7YS</p> <hr/> <p>NEWTON AYCLIFFE Unit 23 Northfield Way Aycliffe Industrial Park Newton Aycliffe DL5 6EJ</p> <hr/> <p>SHEFFIELD Pennine House Roman Ridge Road Sheffield S9 1GB</p>
<p style="text-align: center;">SCOTLAND</p> <p>ABERDEEN 54 Claremont Street Aberdeen AB10 6RA</p> <hr/> <p>AUCHTERMUCHTY 33a Burnside Auchtermuchty Fife KY14 7AJ</p> <hr/> <p>BLANTYRE Unit 5 Block 2 Auchenraith Ind. Estate Rosendale Way Blantyre G72 0NJ</p> <hr/> <p>DUMFRIES 93 Irish Street Dumfries DG1 2 PQ</p> <hr/> <p>DUNOON 7 Hill Street Dunoon Argyll PA23 7AL</p> <hr/> <p>EDINBURGH Unit 12 Dumbryden Ind. Estate 2 Dumbryden Road Edinburgh EH14 2AB</p> <hr/> <p>GLASGOW Unit 4 Wellington Road Bishopriggs Glasgow G64 2SA</p> <hr/> <p>INVERNESS Unit 3BI Smithton Ind. Estate Smithton Inverness IV2 7WL</p> <hr/> <p>ISLE OF ARRAN R Haggerty Bruach Blackwaterfoot Isle of Arran</p> <hr/> <p>ISLE OF BARRA J Zerfah 244 Bruernish Isle of Barra Western Islands HS9 5QY</p> <hr/> <p>ISLES OF BUTE Walker Engineering Glenmhor Upper Serpentine Road Rothsay Isle of Bute PA20 9EH</p>	<p style="text-align: center;">NORTHERN IRELAND</p> <p>BELFAST Owenmore House Kilwee Business Park Dunmurry Belfast BT17 0HD</p>	<p style="text-align: center;">NORTH WEST</p> <p>BIRKENHEAD 1 Kelvin Park Dock Road Birkenhead CH41 1LT</p> <hr/> <p>CARLISLE Unit 7 James Street Workshops James Street Carlisle Cumbria CA2 5AH</p> <hr/> <p>ISLE OF MAN South Quay Ind. Estate Douglas Isle of Man IM1 5AT</p> <hr/> <p>BOLTON Unit B Central Industrial Estate St Marks Street Bolton BL3 6NR</p> <hr/> <p>PRESTON Unit 250 Dawson Place Bamber Bridge Preston Lancashire PR5 8AL</p> <hr/> <p>STOCKPORT Unit 20 Haigh Park Haigh Avenue Stockport SK4 1QR</p>
	<p style="text-align: center;">WALES</p> <p>CARDIFF Unit 4 Guardian Industrial Estate Clydesmuir Road Cardiff CF2 2QS</p> <hr/> <p>CLYWD Unit 6-7 Coed Parc Abergele Road Rhuddlan Clwyd LL18 5UG</p> <hr/> <p>DYFED Unit 9 St. Clears Business Park Tenby Road St. Clears Carmarthen SA33 4JW</p> <hr/> <p>OSWESTRY Plas Ffynnon Warehouse Middleton Road Oswestry SY11 2PP</p>	

To contact your local Service Force Centre telephone 08705 929 929

MIDLANDS		LONDON & EAST ANGLIA		SOUTH EAST	
BIRMINGHAM	66 Birch Road East Wyrley Trading Estate Witton Birmingham B6 7DB	BECKENHAM	11a Gardner Ind. Estate Kent House Lane Beckenham Kent BR3 1QZ	ASHFORD	Unit 2 Bridge Road Business Centre Bridge Road Ashford Kent TN23 1BB
BOURNE	Pinfold Road Bourne PE10 9HT	CHELMSFORD	Hanbury Road Widford Ind. Estate Chelmsford Essex CM12 3AE	FLEET	Unit 1 Redfields Ind. Estate Church Crookham Fleet Hampshire GU13 0RD
BRIDGNORTH	68 St. Mary's Street Bridgnorth Shropshire WV16 4DR	COLINDALE	Unit 14 Capitol Park Capitol Way Colindale London NW9 0EQ	HAYWARDS HEATH	21-25 Bridge Road Haywards Heath Sussex RH16 1UA
GLOUCESTER	101 Rycroft Street Gloucester GL1 4NB	ELTHAM	194 Court Road Mottingham Eltham London SE9 4EW	TONBRIDGE	Unit 30 Deacon Trading Estate Morley Road Tonbridge TN9 1RA
HEREFORD	Units 3 & 4 Bank Buildings Cattle market Hareford HE4 9HX	ENFIELD	284 Alma Road Enfield London EN3 7BB	SOUTH WEST	
HIGHAM FERRERS	30 High Street Higham Ferrers Northants NN10 8PL	GRAVESEND	Unit B4 Imperial Business Estate West Mill Gravesend Kent DA11 0DL	BARNSTAPLE	Main Road Fremington Barnstaple North Devon EX31 2NT
ILKESTON	Unit 2 Furnace Road Ilkeston DE7 5EP	IPSWICH	Unit 6C Elton Park Business Centre Hadleigh Road Ipswich IP2 0DD	BOURNEMOUTH	63-65 Curzon Road Bournemouth Dorset BH1 4PW
LEICESTER	Unit 7 Oaks Industrial Estate Coventry Road Narborough Leicestershire LE9 5GF	LETCHWORTH	16-17 Woodside Ind. Park Works Road Letchworth Herts SG6 1LA	BRIDGEWATER	6 Herswell Business Park Salmon Parade Bridgwater Somerset TA6 5PY
LINCOLN	Unit 8 Clifton Street Stone Field Park Lincoln LN5 8LQ	LONDON	2 - 4 Royal Lane Yiewsley West Drayton Middlesex UB7 8DL	BRISTOL	11 Eldon Way Eldonwall Trading Estate Bristol BS4 3QQ
NEWCASTLE UNDER LYME	18-21 Croft Road Brampton Ind. Estate Newcastle under Lyme Staffordshire ST5 0TW	MAIDENHEAD	Reform Road Maidenhead Berkshire SL6 8BY	EMSWORTH	266 Main Road Southbourne Emsworth PO10 8JL
REDDITCH	13 Thornhill Road North Moons Moat Redditch Worcestershire B98 9ND	MOLESEY	10 Island Farm Avenue West Molesey Surrey KT8 2UZ	ISLE OF WIGHT	Unit 8 Enterprise Court Ryde Business Park Ryde Isle of Wight PO33 1DB
TAMWORTH	Unit 3 Sterling Park Claymore Tamworth B77 5DQ	NEWBURY	9 Pipers Court Berkshire Drive Thatcham Berkshire RG19 4ER	NEWTON ABBOT	Unit 2 Zealley Ind. Estate Kingsteignton Newton Abbot TQ12 3TD
WORCESTER	Units 1 & 2 Northbrooks Close Gregorys Mill Ind. Estate Worcester WR3 8BP	NORWICH	2b Trafalgar Street Norwich NR1 3HN	REDRUTH	Unit 7D Pool Ind. Estate Druids Road Redruth Cornwall TR15 3RH
		SUNBURY	Unit 1a The Summit Hanworth Road Sunbury on Thames TW16 5DB		

Installation Instructions

-  It is dangerous to alter the specifications or attempt to modify this product in any way.
-  Care must be taken to ensure that the appliance does not stand on the electrical supply cable.
-  Any electrical work required to install this appliance should be carried out by a qualified electrician or competent person.

Technical Specifications

DIMENSIONS	Height Width Depth	85 cm (33.5") 60 cm (23.6") 58 cm (22.7")
POWER SUPPLY VOLTAGE TOTAL POWER ADSORBED		230-240 V/50 Hz 2650 W (13A)
MAXIMUM RECOMMENDED LOAD	Cotton, linen Synthetics	6 kg (13 lbs) 2.5 kg (5.5 lbs)
DRUM VOLUME		108 l
CONSUMPTIONS	Cotton, linen Cotton, linen	3.3 kWh (5 kg store dry) 2.7 kWh (5 kg iron dry)

- CE** This appliance complies with the following E.E.C. Directives:
- 73/23 EEC of 19.2.73 (Low Voltage Directive) and subsequent modifications;
 - 89/336 EEC of 3.5.89 (Electromagnetic Compatibility Directive) and subsequent modifications.

Unpacking

Warning !

 Slide out the polythene bag containing the polystyrene block(s) before using the appliance.

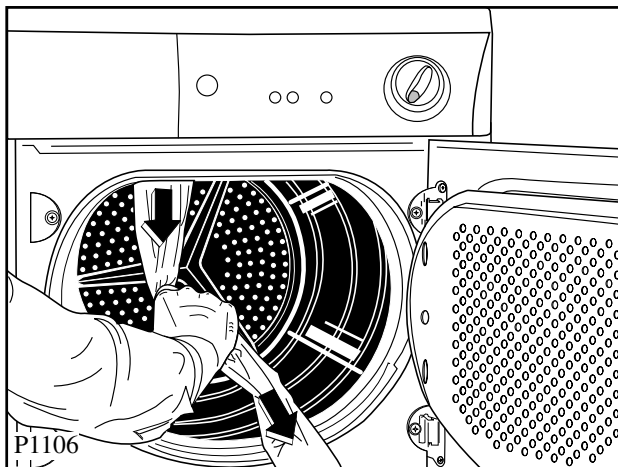

Positioning

It is recommended that, for your convenience, the machine is positioned close to your washing machine.

Whilst drying, the tumble dryer will expel a certain amount of warm, very moist air, and this should be removed from the room as quickly as possible to prevent condensation. In an extremely well ventilated room or close to an open window, this may occur naturally.

However, in general, it is better to carry the dryer's exhaust outside via the 100 mm diameter flexible hose supplied with the appliance; ending either temporarily at an open window, or permanently at a fixed ventilation grille, fitted to an exterior wall or window.

The tumble dryer must be installed in a clean place, where dirt does not build up.

Make sure there are no obstructing items or material near the air-intake louvres provided at the back (e.g. paper, rags etc.).

To keep vibration and noise to a minimum when the dryer is in use, it should be placed on a firm, level surface.

Once in its permanent operating position, check that the dryer is absolutely level with the aid of a spirit level. If it is not, raise or lower the two adjustable feet at the front of the machine until it is.

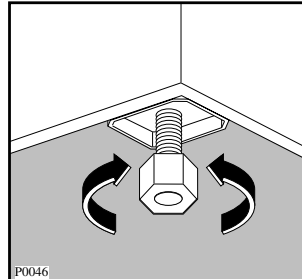

The feet must never be removed.

Do not restrict the floor clearance through deep-pile carpets, strips of wood or similar. This might cause heat build-up which would interfere with the operation of the appliance.

Important

When operating the tumble dryer, the room temperature must not exceed 35°C, as it may affect the performance of the appliance.

Fitting the vent hose

To simplify the installation, there is a choice of vent outlets: one at the back, the others in the left and right-hand side.

Connect the hose to whichever is the more convenient by pulling the ring nut (A) from the vent outlet at the back, screwing it on to the hose and pushing it firmly back into place.

The unused vents should now be sealed with the special snap covers provided.

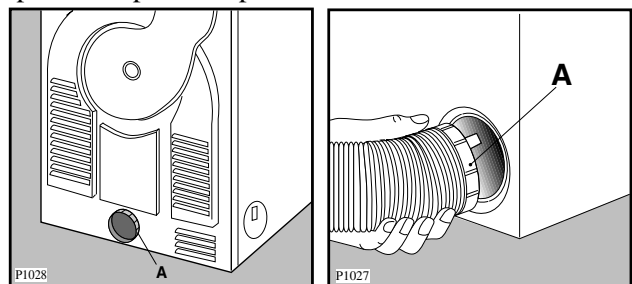

Advice: If the hose is long and the room temperature low, the moisture might condense to water inside the hose. **This is an unavoidable natural phenomenon.** To prevent this water from lying in the hose or flowing back into the tumble dryer, it is advisable to drill a small hole (dia. 3 mm) in the lowest point of the hose and to place a small container below it. (See picture, point B).

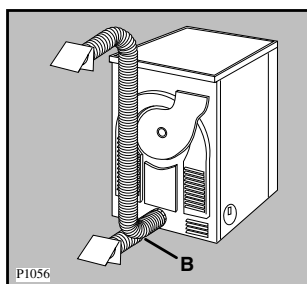

Once connected to the dryer, run the vent hose to the desired outlet point, ensuring that the run's overall length is less than 2 m, and that it contains no more than two bends. As to the outlet itself, if you have decided on a fixed wall/window grille, a good local builder's merchant should be able to supply you with the necessary fittings and installation advice.



It is important not to connect the vent hose to, for example, a cooker hood, or a chimney or flue pipe designed to carry the exhaust from a fuel burning appliance.

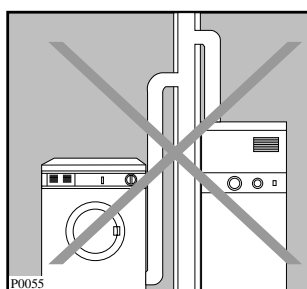

Note that to avoid condensation problems, it is essential that the dryer be fitted with the flexible hose to carry its "exhaust" at least beyond the kitchen units; preferably outside the kitchen.

In order to prevent the appliance from overheating, it is important that the steam exhaust is unobstructed. Therefore, in case of a permanent hose fitted to an exterior wall or ceiling, it must be ensured an exhaust capacity of at least 150 m³/h.

If the dryer is fitted next to kitchen units, make sure that the vent hose is not squashed. If the hose is partially squashed, drying efficiency will be reduced, resulting in longer drying times and higher energy consumption.

If the hose is completely squashed, the safety cut-outs with which the machine is fitted may operate.

Door reversal

To make it easier to load or unload the laundry the door can be reversed.

This operation must be carried out by qualified personnel.

Please contact the nearest Zanussi Service Centre.

Stacking kit

A special stacking kit is available through your dealer, to enable the mounting of the dryer on top of your washing machine.

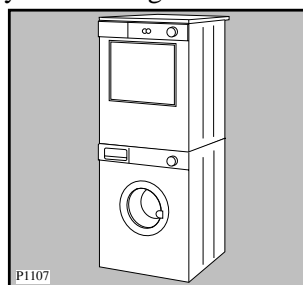

Electrical connection

Any electrical work required to install this appliance should be carried out by a qualified electrician or competent person.



WARNING: THIS APPLIANCE MUST BE EARTHED.

The manufacturer declines any liability should this safety measure not be observed.

Before switching on, make sure the electricity supply voltage is the same as that indicated on the appliance's rating plate. (See picture on page 5).

The appliance is supplied with a 13amp plug fitted. In the event of having to change the fuse in the plug supplied, a 13amp ASTA approved (BS1362) fuse must be used.

Should the plug need to be replaced for any reason, proceed as described below.

The wires in the mains lead are coloured in accordance with the following code:

Green and Yellow	- Earth
Blue	- Neutral
Brown	- Live

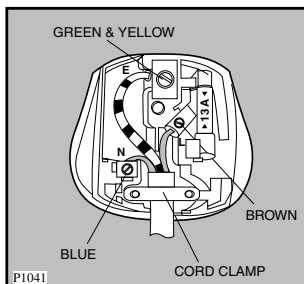

The wire coloured green and yellow must be connected to the terminal marked with the letter «E» or by the earth symbol \perp or coloured green and yellow.

The wire coloured blue must be connected to the terminal «N» or coloured black.

The wire coloured brown must be connected to the terminal marked «L» or coloured red.

Upon completion there must be no cut, or stray strands of wire present and the cord clamp must be secure over the outer sheath.

WARNING:



A cut off plug inserted into a 13 amp socket is a serious safety (shock) hazard.

Ensure that the cut off plug is disposed of safely.

Permanent connection

In the case of permanent connection it is necessary that you install a double pole switch between the appliance and the electricity supply (mains), with a minimum gap of 3mm between the switch contacts and of a type suitable for the required load in compliance with the current electrical regulations.

The switch must not break the yellow and green earth cable at any point.

 **From the Electrolux Group. The world's No. 1 choice.**

The Electrolux Group is the world's largest producer of powered appliances for kitchen, cleaning and outdoor use. More than 55 million Electrolux Group products (such as refrigerators, cookers, washing machines, vacuum cleaners, chain saws and lawn mowers) are sold each year to a value of approx. USD 14 billion in more than 150 countries around the world.